

SMART HOME THEATER PROJECTOR

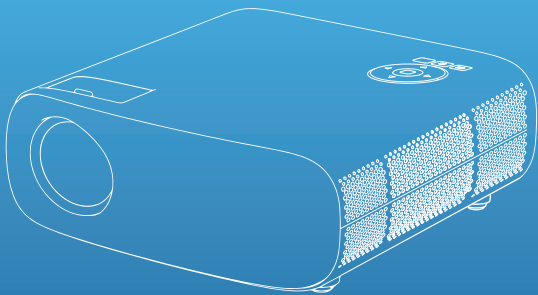

User Guide

Please read this user's guide carefully before operating the projector, and save this guide for future use.

English







**Thank you
for purchasing
our projector**

**If you have any further enquiries or need any
further assistance, please contact us**

Precautions for Use

Follow these safety instructions and read these helpful tips before setting up and using the projector.

Important Safety Instructions

	Do not disassemble the projector. If needed, please contact your dealer for repair/replacement.
	Do not use the different power source, it may result in fire or electric shock. Please use the indicated type of power source.
	Do not look into the lens when the projector is operating. The bright light may damage your eyes.
	Do not use the projector near water or sources of heat.
	Place the projector on an even surface or stable stand. If the projector is mounted on a ceiling, it should be installed by qualified mounting hardware which designed for use with this projector.
	Unplug the projector after powering down.
	In order to maintain the performance and reliability of the projector, please leave at least 30CM between the projector and the wall.

Helpful Tips

For incredible clarity and optimum results, operating the projector in a dark environment is recommended.

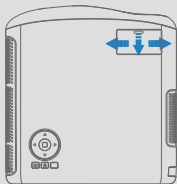

You can slide the focus wheel left and right until you get a clear image.

Please understand that the projector makes noise for heat dissipation during working. Nevertheless, it will not affect watching experiences when connected to an audio device.

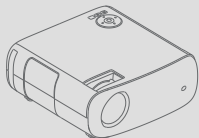
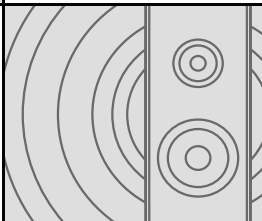

Projector is ideal for home entertainment, such as videos watching, photos viewing and games playing etc. Please be advised that the projector is not for business data presentation.

Projector Features

projector includes these special and outstanding features:

Incredible Watching Experiences

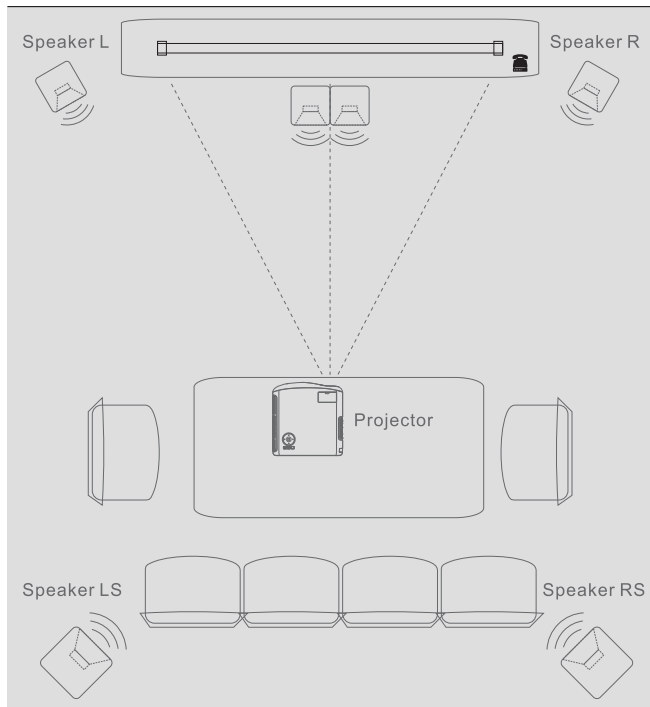

Product Box Contents

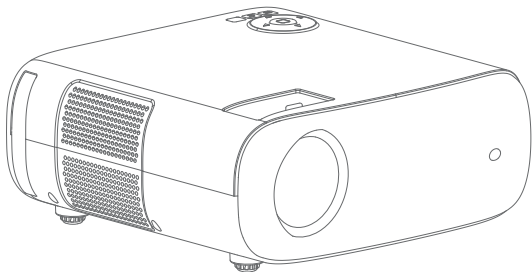

Projector

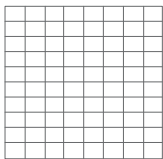

Dust net



Remote control



Power cord

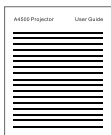

Instruction manual



Cleaning cloth



3-in-1 AV cable

Projector Part Locations

Front/side

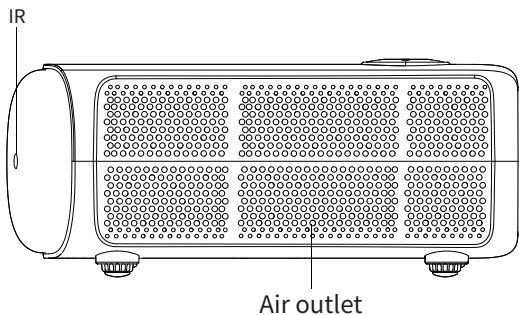
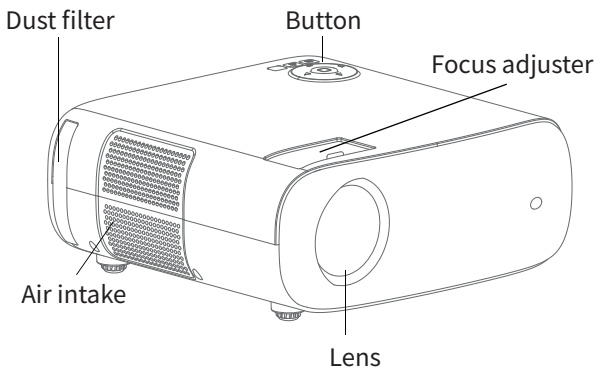

Rear / Bottom

1. RJ45 Network cable interface
2. USB port
3. HDMI port
4. Audio jack
5. AV input port
6. IR receiver
7. AC input port

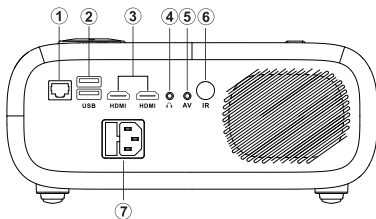



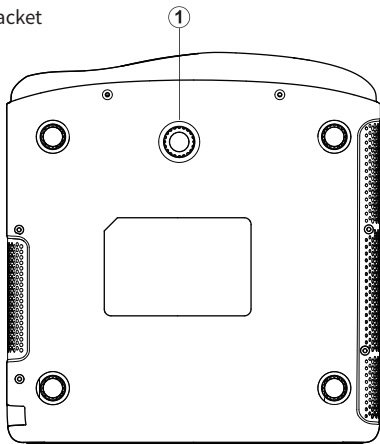



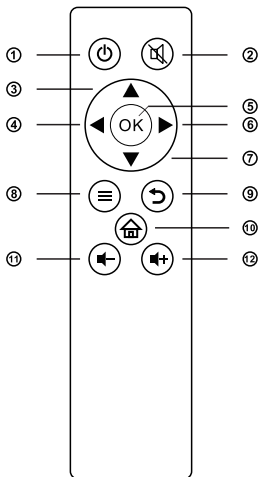



1. Manual lift bracket



Remote Control



1. Power Button
2. Mute Button
3. Up Button
4. Left Button
5. OK Button
6. Right Button
7. Down Button
8. Setting Button
9. Exit Button
10. Home Button
11. Volume Down Button
12. Volume Up Button

 turns the projector on or off	OK selects and confirms options
 turns off sound	 accesses projector menu system
 selects upward movement	 cancels/exits functions
 selects leftward movement	 back to homepage
 selects rightward movement	 adjusts speaker volume
 selects downward movement	 adjusts speaker volume

Setting Up the Projector

Before projecting, please be familiar with the following suggestions of placement, installation and adjustment.

Projector Placement and Installation

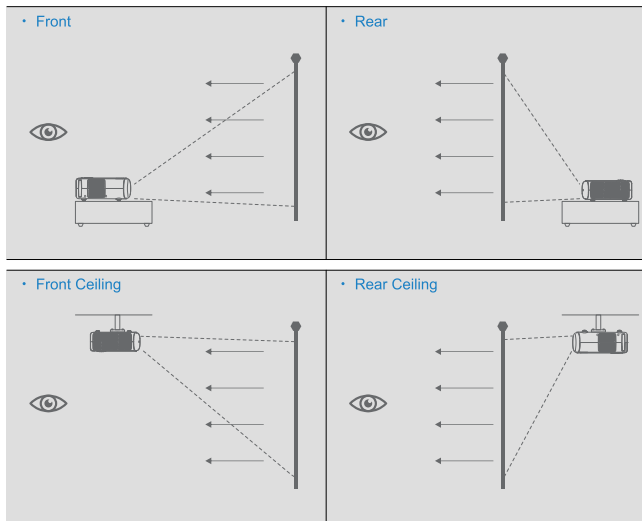

Whether the way you choose to project your images or videos, please keep these suggestions in mind:

1. Ensure the place you set the projector is sturdy and even;
2. Do not block the vents and always leave enough space for heat dissipation;
3. If the way you project is from the ceiling or from the rear, please ensure to select the correct projection option in the menu system.

Projection Distance and Screen Size

The throw distance, zoom factor, aspect ratio, and other settings determine the approximate size of the image. Please refer to the following table for the relationship between projection distance and image size.

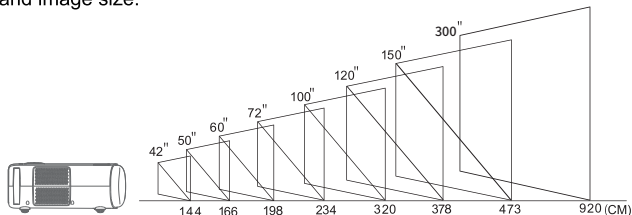

Projector Adjustment

Except setting suitable throw distance, you can adjust the focus ring manually before projecting your images or videos:

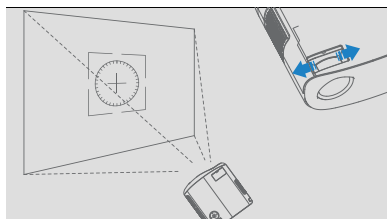

Rotate the focus ring to adjust the clarity of the projected image until it reaches to crystal clear.

Automatic Vertical Keystone function.

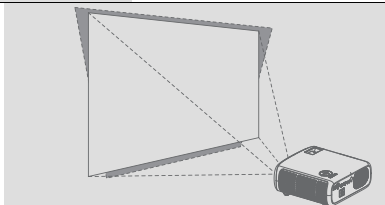

Keystone correction

Place the projector up and down at an angle,
The projector will automatically correct to the best picture.

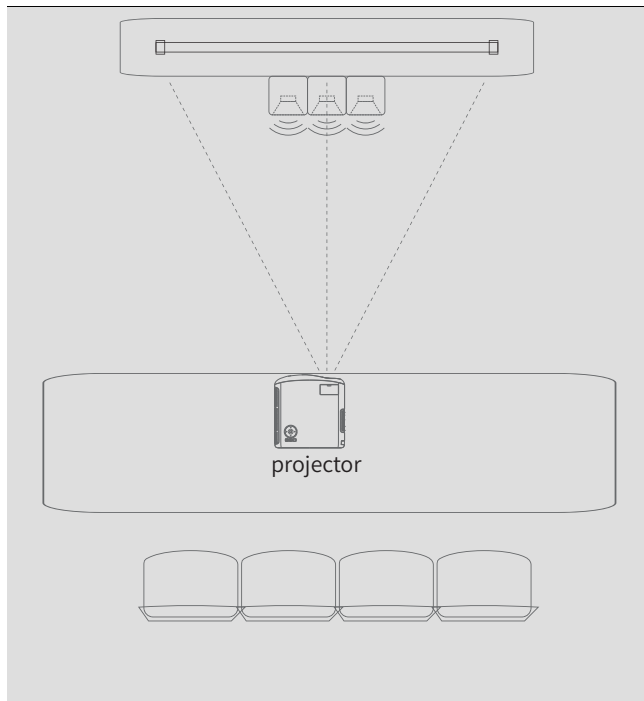

Basic Projector Operations

Basic operations provided help you to get started quickly.

- Power on the projector

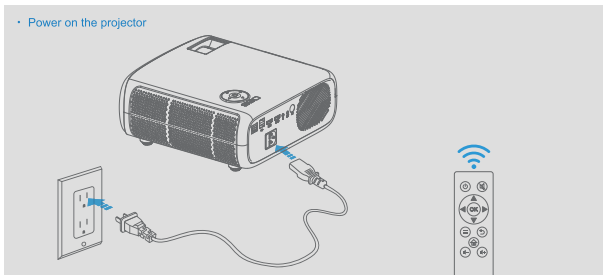

Indicator light will on after plugging in the power cord. Then press the Power button on the projector or on the remote control, it enters into multimedia interface within 2 to 5 seconds.

wifi connection guide

- enter setting

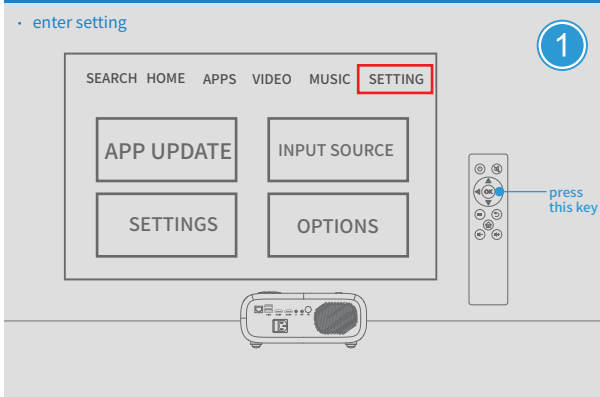

On the home page, press the right key on the remote control to enter the settings.

2

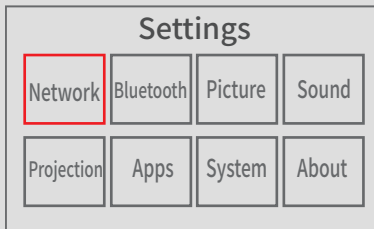

In the system settings interface, enter the network and select WIFI and enter the password to connect.

Bluetooth Remote Control User Guide

1

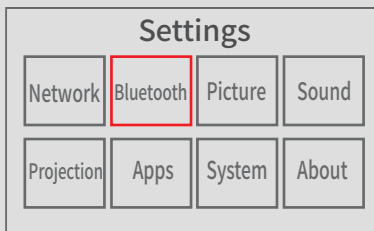

In the system settings interface, enter Bluetooth and select the corresponding device to connect.

Projector Connections

You can connect the projector to a USB device, an audio source, an AV equipment, a VGA device or a HDMI device to enjoy your Presentation, images, or other videos, with premium sound.

Introduction to Ports

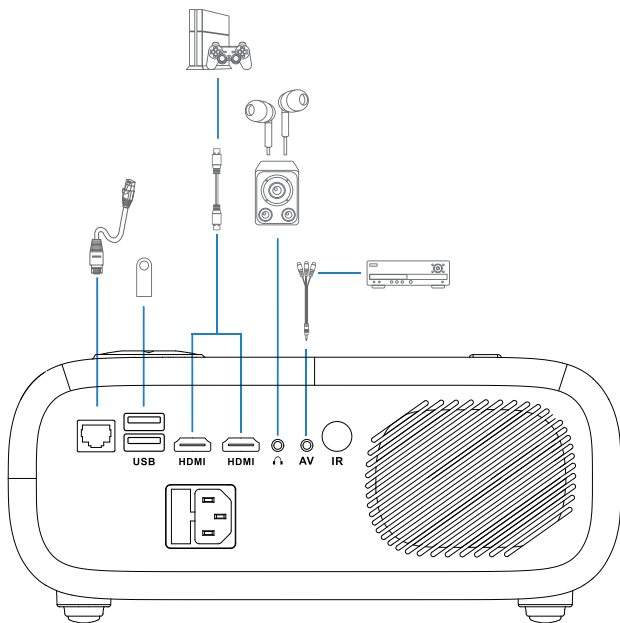

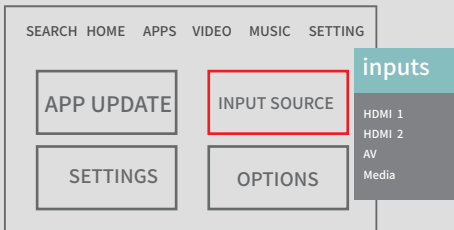

device connection



Connecting to a computer setting reference

The shortcut keys for output signals from different brands are different. See the computer manual for details.

(1) Press the windows key  + P key on the keyboard and select "Copy".

(2) Find the button of the " 

" symbol on the F1~F12 buttons on the keyboard, and press the Fn button at the same time to select "Copy".

Common key combinations are as follows:

Lenovo	Fn+F3	Fujitsu	Fn+F10
Dell	Fn+F8	Haier	Fn+F3
HP	Fn+F4	NEC	Fn+F3
ThinkPad	Fn+F7	Panasonic	Fn+F3
Asus	Fn+F8	Sharp	Fn+F5
Acer	Fn+F5	Hitachi	Fn+F7
Samsung	Fn+F4	TOSHIBA	Fn+F5
Sony	Fn+F7		

Note: The above content is for reference only, please refer to the computer manual

Projector Cleaning and Maintenance



For optimum watching experiences and longer lifetime, please clean the projector periodically.



For projector maintenance, please seek help from or under the guidance of specified persons.



If it is necessary to replace any parts of the projector, please feel free to contact the dealer or qualified customer service team.



Before cleaning and maintaining the projector, please turn off the projector and unplug the power cord.

Projector Cleaning

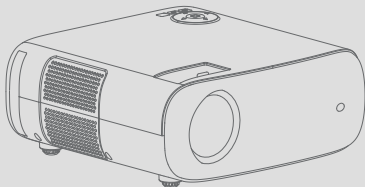

Always keep the projector clean to avoid affecting images quality and ventilation system during working caused by dust, dirt and smudge.



Cleaning the Projector Case

Use a piece of dry, soft and lint-free cloth to remove dust or dirt;

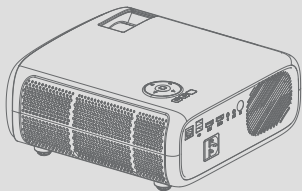

Use a piece of moistened and soft cloth with a little water and mild soap to remove stubborn dirt.

Cleaning the Lens

Gently wipe the lens with a piece of dry and non-abrasive cloth or paper to remove dust or dirt;

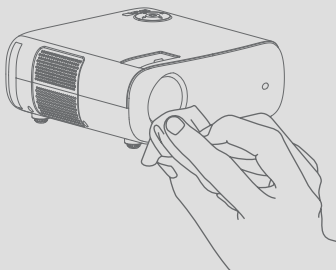

Gently wipe the lens by a piece of moistened (with a little water), non-abrasive and lint-free cloth to remove stubborn dirt.

Use a soft brush or a special designed small vacuum to remove the dust.

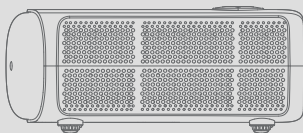

- Note: For cleaning process, do Not spray any liquid (included water) directly on any parts of the projector. Do Not use the chemical liquid to clean the projector which will damage the projector.

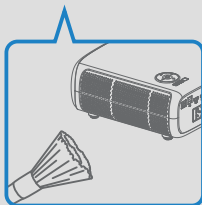

Batteries Replacement of the Remote Control

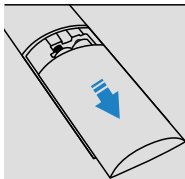

1. Open battery cover of the remote control;

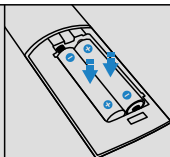

2. Insert batteries with the + and – ends as the indicators on the battery box showed;

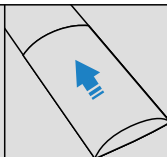

3. Close battery cover of the remote control properly.

Projector Maintenance

For this part, we only offer the basic maintaining suggestions. If you have any further requirements (replacement or repair), please contact the dealer or qualified customer service team.

Technical Specifications

To know product better and use projector properly, please read the table below:

Native Resolution	1920 x 1080 pixels
Light	LED
Keystone	Auto Keystone
Screen Size	50-300inch
Projection Distance	1.4-9.2M
Display Ratio Screen Scale	4:3/16:9
Interface	1 x RJ45 Port
	1 x AC Input
	2 x USB Ports
	1 x AV Input
	2 x HDMI Port
	1 x 3.5mm Audio Jack
Consumption	160W
Power Supply	AC 90~260V
Operating temperature	-10°C~45°C
Supported Languages	multi-lingual
Product Size	287*274*122MM

Troubleshooting

As a high-tech product, the projector combined with optical, mechanical and electronic components and equipped with a protective and complicated circuit inside. To quickly solve your problems and to prevent improper using and settings, please follow operations below. If your problems or enquiries cannot be eliminated after reading the table, please do not hesitate to contact us.

Problem Description	Troubleshooting
The projector won't turn on	Check if the power source is the indicated one and the power cord is connected correctly. Make sure the power cord is not defective.
Lamp does not work after turning on the projector	Ensure power cord and power source are connected correctly. If the lamp gets damages, please contact us to replace the lamp
No images	Check whether the format and resolution of images are supported by the projector.
No response from remote control	Check whether batteries of the remote control run out or are installed correctly. Make sure there is no obstacle between the remote control and IR receiver. Always use the remote control within its effective distance (4m).
Obscure/Blurred images	Please rotate the focus ring, adjust the keystone and throw distance until the projected image is clear. Ensure the lens is clean.
Abnormal sound	Ensure the audio device is connected correctly and function well. Check if the mute or minimum volume mode is set.

